

Pivot Point
FOR ARMREST

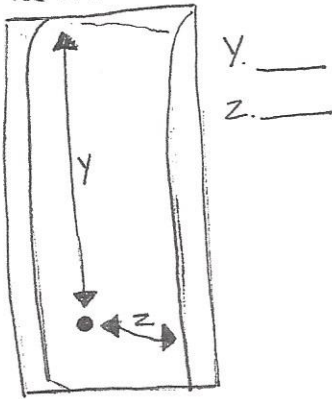

SEAT BELT

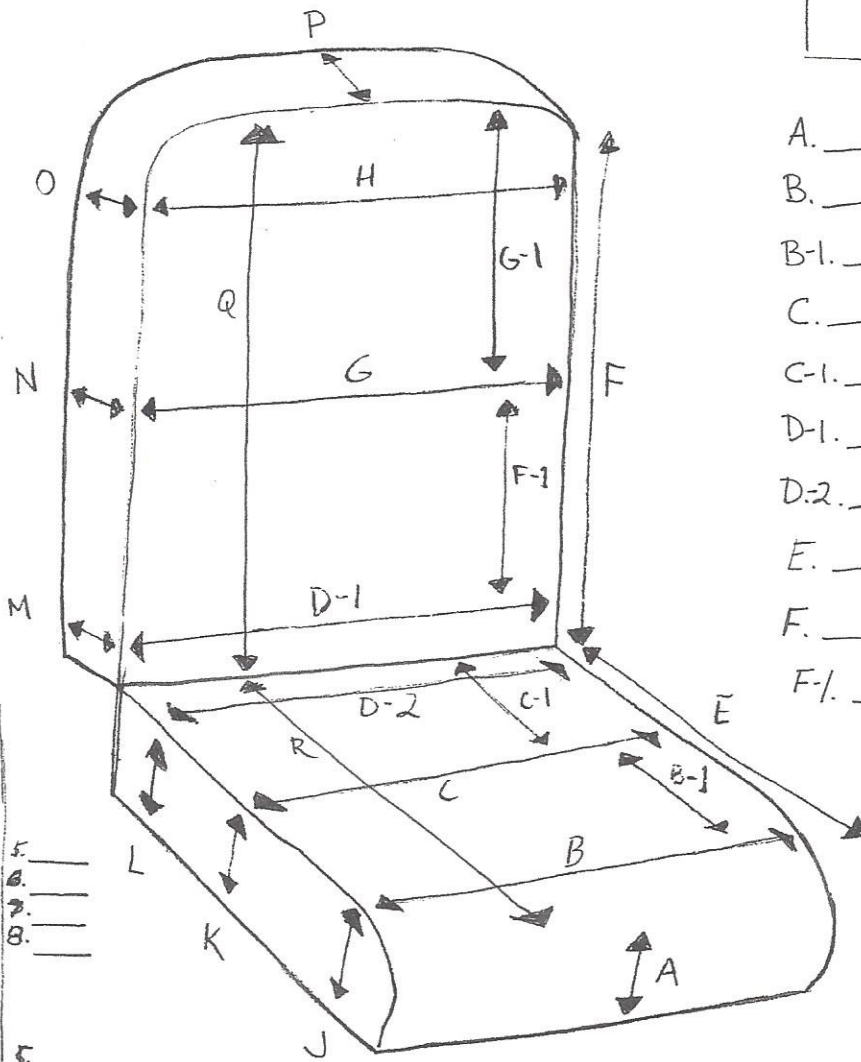
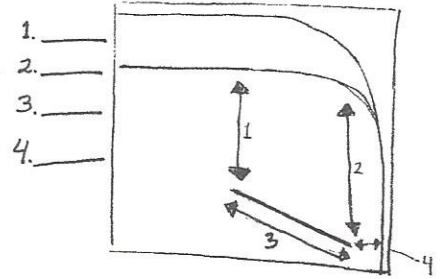

- A. _____
- B. _____
- B-1. _____
- C. _____
- C-1. _____
- D-1. _____
- D-2. _____
- E. _____
- F. _____
- F-1. _____
- G. _____
- G-1. _____
- H. _____
- J. _____
- K. _____
- L. _____
- M. _____
- N. _____
- O. _____
- P. _____
- Q. _____
- R. _____

INDICATE POWER
ON SIDE SKIRT

DRIVER OUTSIDE

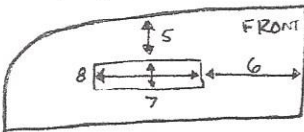

DRIVER INSIDE

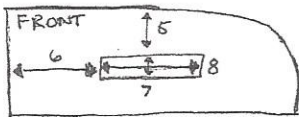

PASSENGER OUTSIDE

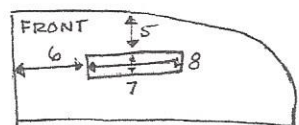

PASSENGER INSIDE

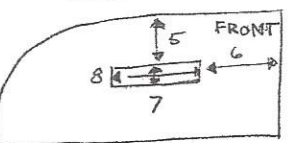

- 5. _____
- 6. _____
- 7. _____
- 8. _____
- 5. _____
- 6. _____
- 7. _____
- 8. _____
- 5. _____
- 6. _____
- 7. _____
- 8. _____
- 5. _____
- 6. _____
- 7. _____
- 8. _____

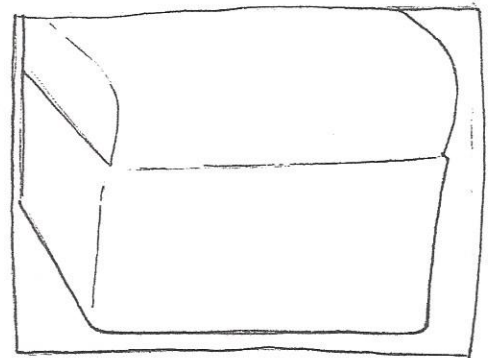

INDICATE BREAK IN VINYL SKIRTING